



Blancett[®]
Turbine Flow Meters

Flow Monitor

B3000 Series

DESCRIPTION

The B3000 Series flow monitor is a flexible, durable, easy-to-use platform for your flow metering applications. Our trusted flow metering technology now offers a new flow monitor with more options and features than ever before with the B3000 Series.

OPERATION

This monitor is capable of accepting low-level frequency input signals typically found in turbine flow sensors. The output signal for these type of sensors is a frequency proportional to the rate of flow. The B3000 monitor uses the frequency information to calculate flow rate and total flow. Through the use of the programming buttons, you can select rate units, total units and unit time intervals among other functions. If required, the flow monitor can easily be reconfigured in the field. Finally, you can choose between simultaneously showing rate and total, or alternating between rate and grand total.

The monitor is available in three levels of functionality and two packaging options. The base model provides all the functions necessary for the most common flow metering applications. The advanced version adds communications capabilities over an RS485 bus using Modbus RTU and control outputs. The third version is a solar-powered model (NEMA 4X only).

Packaging options include a polycarbonate, NEMA 4X version and an aluminum explosion proof enclosure.

APPLICATIONS

The B3000 monitor is suitable for application in a wide variety of metering needs. A few of the more common industries are:

- Secondary oil recovery applications
- Remediation and reclamation
- Fracture/refracture
- Coal bed methane
- Regulatory compliance and environmental accountability
- Industrial chemicals
- Aggressive chemical processing applications
- Semiconductor manufacturing
- Fertilizer production and dispensing
- Pesticide manufacture
- Liquid batching and water cooling



FEATURES

- Robust alarm parameters provide faster warning when something changes in the process or pipeline.
- Greater control and greater visibility of batch operations.
- Advanced connectivity options allow you to connect meters to your network for remote monitoring and process automation capabilities.
- Solar, battery, and 4...20 milliamperes loop power options provide the ability to install in a remote location and be up and running immediately, maintain readings and settings during power loss, and a battery life up to 6 years.
- Updated display and totalization options provide more flow information, including simultaneous display of rate and total as well as standard, batch and grand totals.
- Various mounting and enclosure options provide a B3000 model for your operation.



Badger Meter

DSY-DS-00691-EN-14 (February 2022)

Product Data Sheet

PART NUMBER CONSTRUCTION

Blancett B3000 Display

| | | | | | | | |
|--------------------------------|------------------------|------------|--|----------|--|-----------|----------|
| | | | | - | | - | |
| Model | Blancett B3000 Display | B30 | | | | | |
| Model | Base | B | | | | | |
| | Advanced | A | | | | | |
| | Solar | S | | | | | |
| Mounting | Meter | | | M | | | |
| | Remote | | | R | | | |
| | Swivel | | | S | | | |
| Units of Measure | Customer Selectable | | | | | CS | |
| For European Units Only | | | | | | | E |

Blancett B3000 Explosion-proof Display

| | | | | | | | |
|--------------------------------|--|------------|--|----------|--|-----------|----------|
| | | | | - | | - | |
| Model | Blancett B3000 Explosion-proof Display | B30 | | | | | |
| Model | Base, Explosion-proof*, Battery & Loop Power | X | | | | | |
| | Advanced, Explosion-proof*, Battery & Loop Power | Z | | | | | |
| Mounting | Remote | | | R | | | |
| Units of Measure | Customer Selectable | | | | | CS | |
| For European Units Only | | | | | | | E |

*For hazardous locations, the monitor must be installed on an explosion-proof rated meter. To maintain compliance, kit P/N B280-737 for meter mounting is required.

SPECIFICATIONS (PAGE 1 OF 2)

| | | | | |
|--|---|---|--|--|
| Display | Common | Simultaneously shows Rate and Total 5 x 7 Dot Matrix LCD, STN Fluid | | |
| | B30A/B/S | 6 Digit Rate, 0.5 inch (12.7 mm) numeric | | |
| | | 7 Digit Total, 0.5 inch (12.7 mm) numeric | | |
| | | Engineering Unit Labels 0.34 inch (8.6 mm) | | |
| | B30X/Z | 6 Digit Rate, 0.37 inch (9.4 mm) numeric | | |
| 7 Digit Total, 0.37 inch (13 mm) numeric | | | | |
| Annunciators | Alarm 1 (A), Alarm 2 (A), Battery Level (■■■■), RS485 Communications (COM) | | | |
| Power | B30A/B/X/Z | Auto switching between internal battery and external loop power; B30A/Z includes isolation between loop power and other I/O | | |
| | | Battery | 3.6V DC lithium D Cell gives up to 6 years of service life | |
| | | Loop | 4...20 mA, two wire, 25 mA limit, reverse polarity protected, 7V DC loop loss | |
| B30S | Internal battery (3.6V DC Nicd) provides up to 30 days of power after 6...8 hours exposure of the integrated photovoltaic cell to direct sunlight | | | |
| Inputs | Magnetic Pickup | Frequency Range | 1...3500 Hz | |
| | | Frequency Measurement Accuracy | ±0.1% | |
| | | Over Voltage Protection | 28V DC | |
| | | Trigger Sensitivity | 30 mV _{p-p} (High) or 60 mV _{p-p} (Low) - (selected by circuit board jumper) | |
| | Amplified Pulse | Direct connection to amplified signal (pre-amp output from sensor) | | |
| Outputs | Analog 4...20 mA | 4...20 mA, two-wire current loop. 25 mA current limit | | |
| | Totalizing Pulse | One pulse for each Least Significant Digit (LSD) increment of the totalizer | | |
| | | Pulse Type (selected by circuit board jumper) | Opto-isolated (Iso) open collector transistor Non-isolated open drain FET | |
| | | Maximum Voltage | 28V DC | |
| | | Maximum Current Capacity | 100 mA | |
| | | Maximum Output Frequency | 16 Hz | |
| | | Pulse Width | 30 mSec fixed | |
| | Status Alarms B30A/Z | Type | Open collector transistor Adjustable flow rate with programmable dead band and phase. | |
| | | Maximum Voltage | 28V DC | |
| | | Maximum Current | 100 mA | |
| | | Pullup Resistor | External required (2.2 k Ohm minimum, 10 k Ohm maximum) | |
| Status Alarms B30B/S/X | None | | | |
| Modbus Digital Communications | B30A/Z | Modbus RTU over RS485, 127 addressable units / 2-wire network, 9600 baud, long integer and single precision IEEE754 formats; retrieve: flow rate, job totalizer, grand totalizer, alarm status and battery level; write: reset job totalizer, reset grand totalizer | | |
| | B30B/S/X | None | | |
| Data Configuration and Protection | B30A/B/X/Z | Two four-digit user selectable passwords; level one password enables job total reset only, level two password enables all configuration and totalizer reset functions Not applicable on solar powered units. | | |

SPECIFICATIONS (PAGE 2 OF 2)

| | | | | | | |
|--|--------------------------------|--|---|---------------------------|-------------------------|-----------|
| Certifications | Safety | B30A/B/S | Class I Division 1, Groups C, D; Class II, Division 1 Groups E, F, G; Class III for US and Canada. Complies with UL 913 and CSA C22.2 No. 157-92 | | | |
| | | B30X/Z | Class I Division 1 Groups B, C, D; Class II, Division 1, Groups E, F, G; Class III for US and Canada Complies with UL 1203 and CSA C22.2 No. 30-M1986 | | | |
| | | | ATEX II 2 G Ex db IIC T4 Gb and ATEX II D Ex tb IIIC T135 °C Db | | | |
| | Entity Parameters | Complies with Directive 2014/34/EU and S.I. 2016/1107 | | | | |
| | | B30A/B only | 4...20 mA Loop: Vmax = 28V DC | I _{max} = 26 mA | C _i = 0.5 µF | Li = 0 mH |
| | | B30A/B/S only | Pulse Output: Vmax = 28V DC | I _{max} = 100 mA | C _i = 0 µF | Li = 0 mH |
| | | B30A/B/S only | Reset Input: Vmax = 5V DC | I _{max} = 5 mA | C _i = 0 µF | Li = 0 mH |
| B30A only | | RS485: Vmax = 10V DC | I _{max} = 60 mA | C _i = 0 µF | Li = 0 mH | |
| B30A/B/S only | Turbine Input: Voc = 2.5V | I _{sc} = 1.8 mA | Ca = 1.5 µF | La = 1.65 H | | |
| EMC | 2004/108/EC and S.I. 2016/1091 | | | | | |
| Measurement Accuracy | Common Accuracy | 0.05% | | | | |
| Response Time (Damping) | Common Response Time | 1...100 seconds response to a step change input, user adjustable | | | | |
| Environmental Limits | Common Limits | -22...158° F (-30...70° C); 0...90% humidity, non-condensing | | | | |
| Materials and Enclosure Ratings | B30A/B/S | Polycarbonate, stainless steel, polyurethane, thermoplastic elastomer, acrylic; NEMA 4X/IP 66 | | | | |
| | B30X/Z | Copper free, epoxy-coated, aluminum, buna seal, NEMA 4X/IP66 | | | | |
| Engineering Units | Liquid | US Gallons, Liters, Oil Barrels (42 US gallons), Liquid Barrels (31.5 US gallons), Cubic Meters, Million US Gallons, Cubic Feet, Million Liters, Acre Feet | | | | |
| | Gas | Cubic Feet, Thousand Cubic Feet, Million Cubic Feet, Standard Cubic Feet, Actual Cubic Feet, Normal Cubic Meters, Actual Cubic Meters, Liters | | | | |
| | Rate Time | Seconds, minutes, hours, days | | | | |
| | Totalizer Exponents | 0.00, 0.0, x1, x10, x100, x1000 | | | | |
| | K factor Units | Pulses/US gallon, pulses/cubic meter, pulses/liter, pulses/cubic foot | | | | |

MOUNTING STYLES

Meter Mount

- Monitor is assembled to the flow meter, creating a compact flow measurement system.
- NEMA 4X (IP 66) enclosure.



Remote Mount

- Ideal when monitor needs to be located away from flow meter. Suitable for high temperature, excessive noise or inaccessible areas.
- NEMA 4X (IP 66) enclosure.
- Panel, DIN rail, and pipe mounting hardware included.
- Cable lengths from 10...100 ft (3...30.5 m) sold separately.

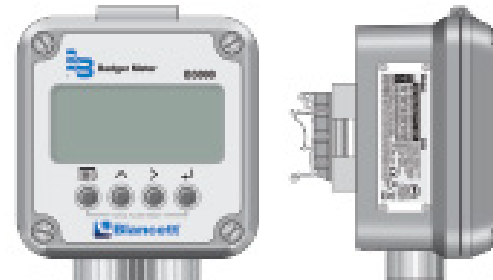

Swivel Mount

- Capable of adjustment pivot of 180 degrees for ease of viewing.
- NEMA 4X (IP 66) enclosure.
- Remote Swivel mount also available, consult factory for details.
- Offers additional protection from elements.

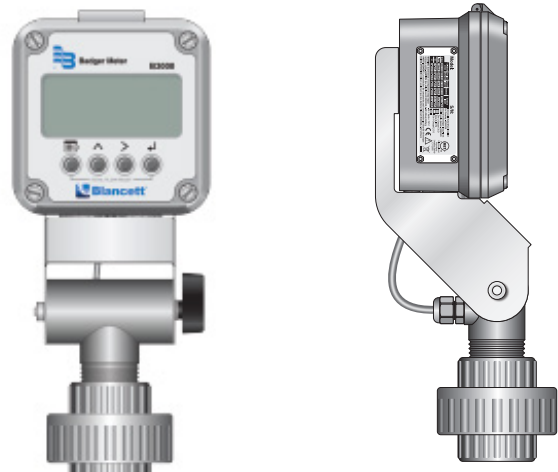

Explosion Proof

- Ideal for hazardous locations.
- NEMA 4X (IP 66) enclosure.
- Rugged compact design.
- Remote or meter mount.



DIMENSIONS

Meter Mount

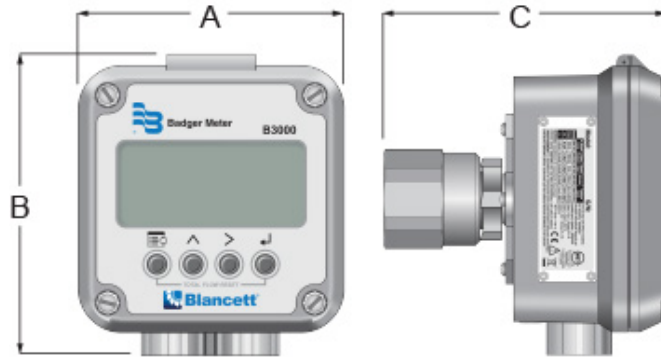

| A | B | C |
|---------------------|---------------------|---------------------|
| 4.50 in. (114.3 mm) | 5.08 in. (129.0 mm) | 4.78 in. (121.4 mm) |

Remote Mount

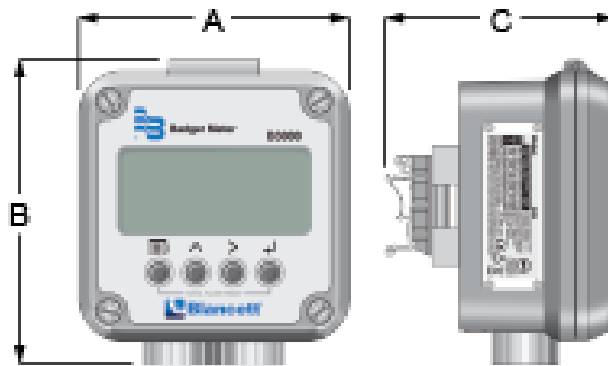

| A | B | C |
|---------------------|---------------------|--------------------|
| 4.50 in. (114.3 mm) | 5.08 in. (129.0 mm) | 3.80 in. (96.5 mm) |

Explosion Proof

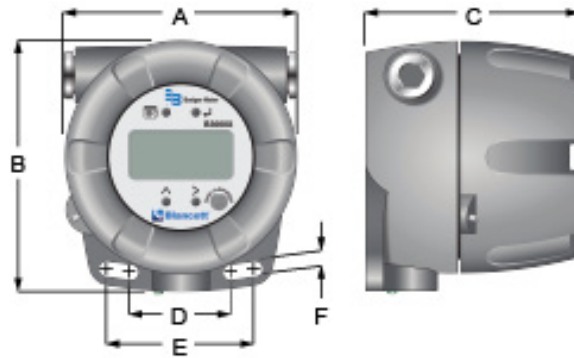

| A | B | C | D | E | F |
|---------------------|---------------------|---------------------|--------------------|--------------------|-------------------|
| 5.25 in. (133.4 mm) | 5.65 in. (143.5 mm) | 4.86 in. (123.4 mm) | 2.25 in. (57.1 mm) | 3.35 in. (85.1 mm) | 0.33 in. (8.4 mm) |

Swivel Mount

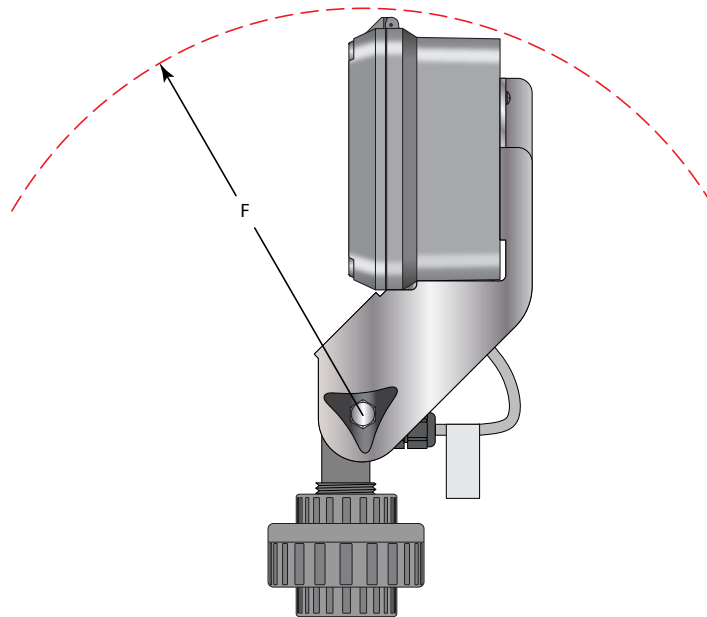
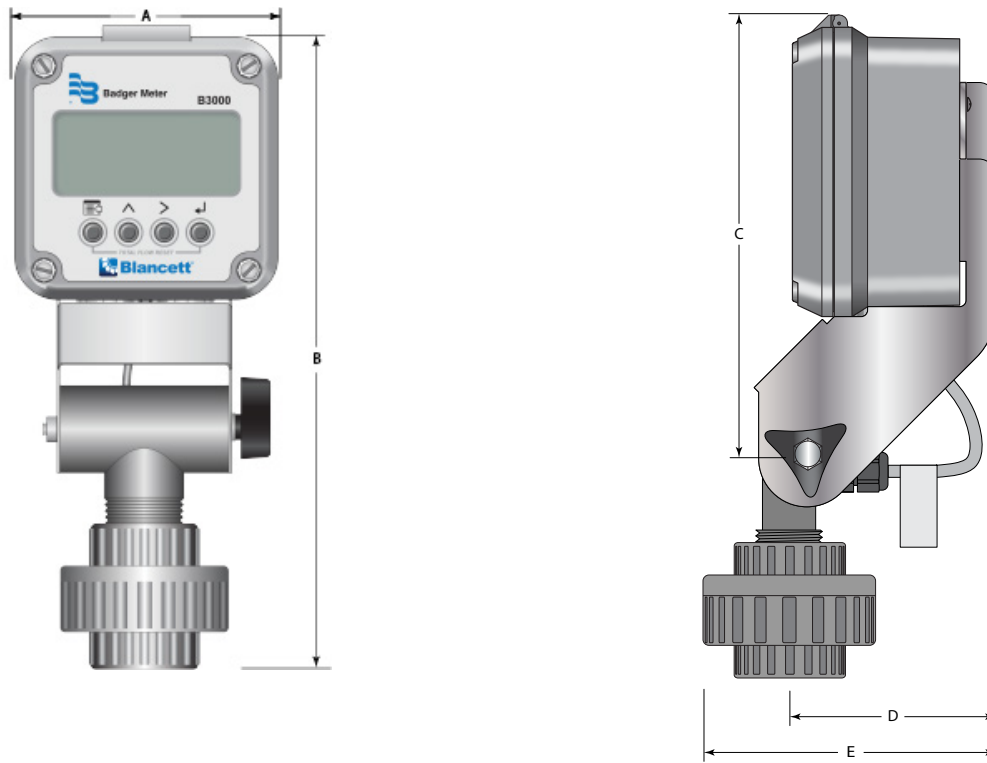

| A | B | C | D | E | F |
|---------------------|---------------------|---------------------|--------------------|---------------------|---------------------|
| 4.50 in. (114.3 mm) | 10.9 in. (276.9 mm) | 6.90 in. (175.4 mm) | 3.21 in. (81.5 mm) | 4.25 in. (107.9 mm) | 7.00 in. (177.8 mm) |

ACCESSORIES

| Part Number | Description |
|-------------|--|
| B280-737 | Explosion-proof Meter Mount Kit, 1 in. connections |
| B280-742 | Explosion-proof Meter Mount Kit, 1/2 in. connections |

Meter Mounting Kits

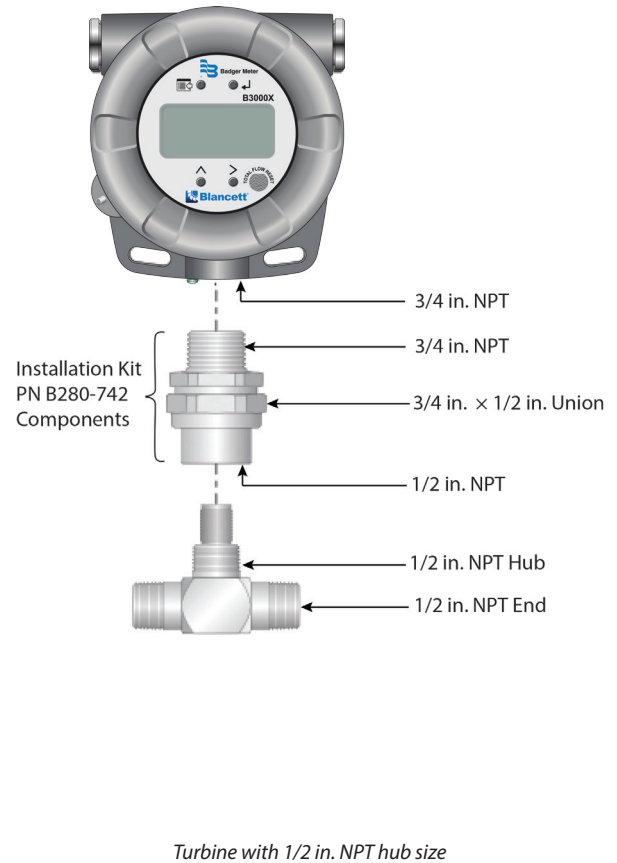
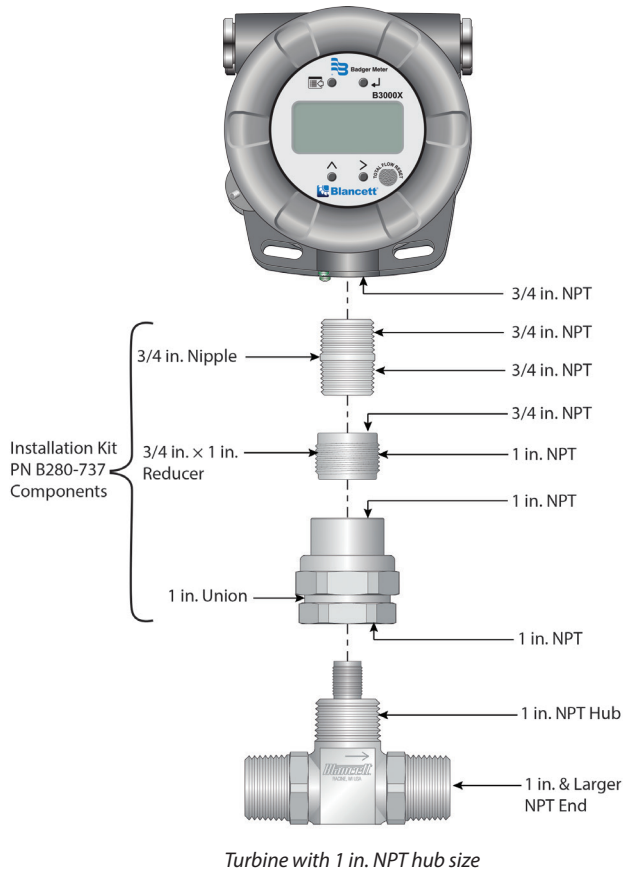

Control. Manage. Optimize.

Blancett is a registered trademark of Badger Meter, Inc. Other trademarks appearing in this document are the property of their respective entities. Due to continuous research, product improvements and enhancements, Badger Meter reserves the right to change product or system specifications without notice, except to the extent an outstanding contractual obligation exists. © 2022 Badger Meter, Inc. All rights reserved.